

Aluminum Enclosures



FEATURES

Maximum RFI/EMI

Shielding properties Excellent heat sinking to dissipate component heat

Flexible options - supplied in standard or custom lengths

Variety of finishes including raw or powder coat; silk screening or overlays

Rugged, durable extruded aluminum

Indoors or outdoor use

Quick turnaround - standard sizes ship from stock

Fast Modification Services including panel cutouts, fasteners, matching end panels, special finishes, labels, silk screening, full or partial assembly

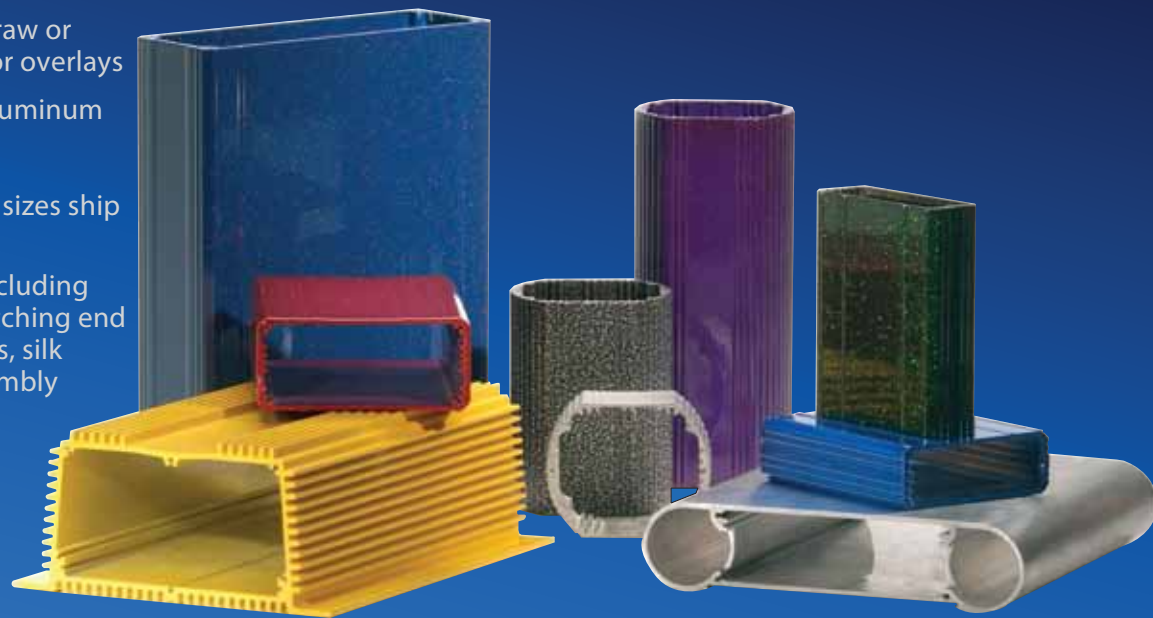

XTech — The Front Panel and Enclosure Source

XTech delivers the enclosure you need - for full production, prototyping or beta testing - with a commitment to meet your budget and schedule.

We offer a wide variety of standard extruded aluminum enclosures from stock.

We also handle all your finishing, labeling, and assembly requirements - to create customized solutions.

XTech enclosures are ideal for a wide range of applications, including:

- Modems
- GPS enclosures
- Wireless transmitters
- Electronic instruments
- Camera enclosures
- Audio components
- Hand held controllers
- Avionics
- Rugged controllers

Aluminum Enclosures

GS - 3517

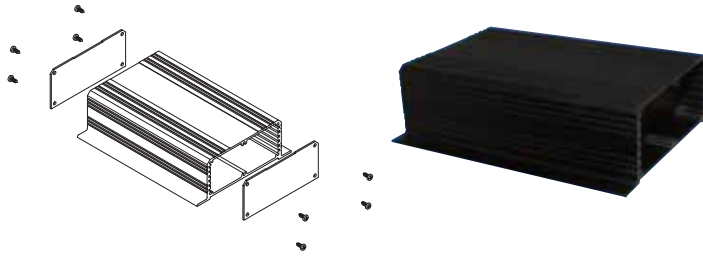
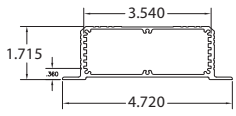

Description	Finish	Size	P/N
Enclosure Base	Mill	4" long	115173
	Mill	6" long	121355
	Black Powder	4" long	118967
	Black Powder	6" long	121358
Flat End Panel	Mill		114271
	Black Powder		121360
Gasket	Black Powder		115685

KB - 6027

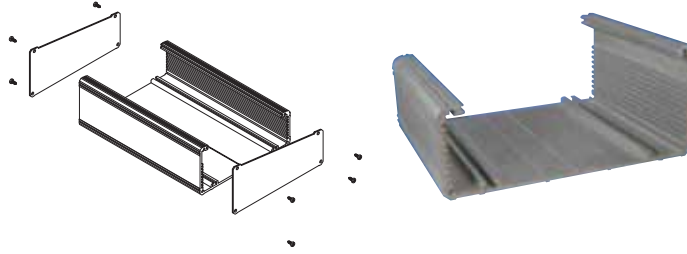
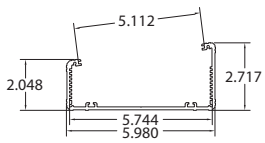

Description	Finish	Size	P/N
Enclosure Base	Mill	5" long	115105
	Mill	8.5" long	114997
Flat End Panel	Mill		114998
Top Panel	Mill	5" long	117897
	Mill	8.5" long	115429

KB - 6017

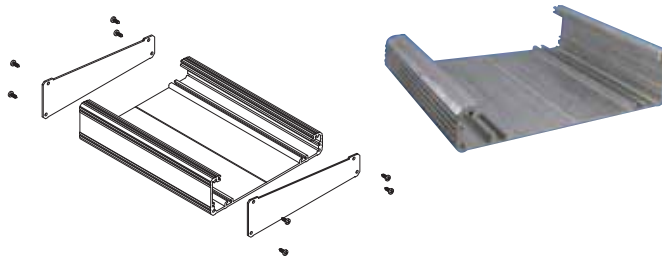
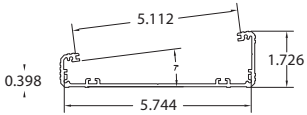

Description	Finish	Size	P/N
Enclosure Base	Mill	5" long	115112
	Mill	8.5" long	115074
Flat End Panel	Mill		115075
Top Panel	Mill	5" long	117897
	Mill	8.5" long	115429

RS - 3010

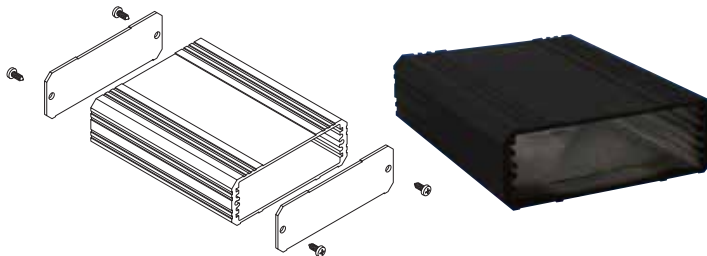
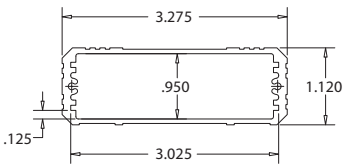

Description	Finish	Size	P/N
Enclosure Base	Mill	4" long	114283
	Mill	6" long	121034
	Black Powder	4" long	121038
	Black Powder	6" long	114588
Flat End Panel	Mill		114992
	Black Powder		121040
Left End Panel	Mill		114996
	Black Powder		121041
Plastic Bezel	Black		113781
Gasket	Black		121618

RS - 2626

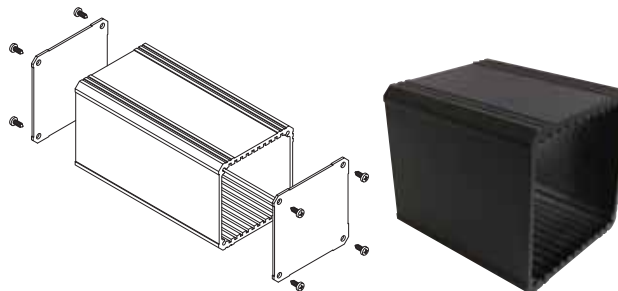
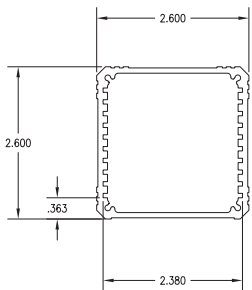

Description	Finish	Size	P/N
Enclosure Base	Mill	3" long	115020
	Mill	4" long	121045
	Black Powder	3" long	121046
	Black Powder	4" long	121048
Flat End Panel	Mill		115028
	Black Powder		121049
Left End Panel	Mill		121410
	Black Powder		121390
Gasket	Black		125130

Aluminum Enclosures

RS - 3516

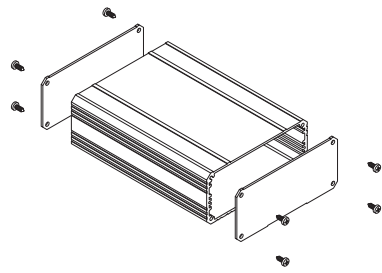
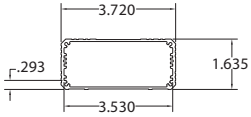

Description	Finish	Size	P/N
Enclosure Base	Mill	4" long	115087
	Mill	6" long	121275
	Black Powder	4" long	121277
	Black Powder	6" long	121278
Flat End Panel	Mill		115016
	Black Powder		121276
Left End Panel	Mill		115017
	Black Powder		121280
Gasket	Black		115685

RS - 4025

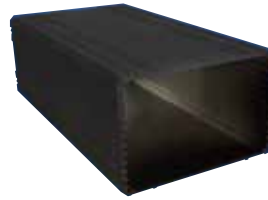
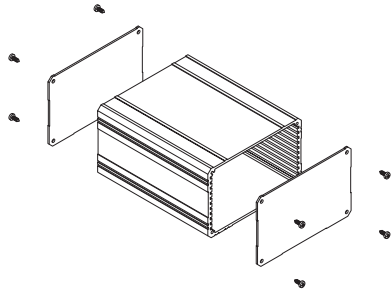
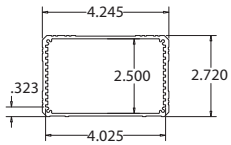

Description	Finish	Size	P/N
Enclosure Base	Mill	6" long	114910
	Mill	8" long	121363
	Black Powder	6" long	121364
	Black Powder	8" long	121365
Flat End Panel	Mill		115082
	Black Powder		121366
Left End Panel	Mill		114924
	Black Powder		121367
Gasket	Black		113948

RS - 5010

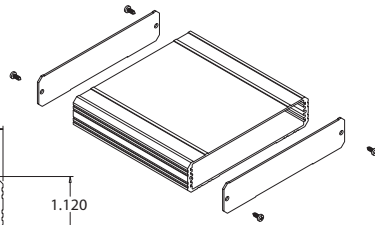
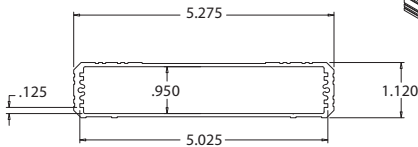

Description	Finish	Size	P/N
Enclosure Base	Mill	6" long	121370
	Mill	8" long	114451
	Black Powder	6" long	121371
	Black Powder	8" long	121372
Flat End Panel	Mill		115081
	Black Powder		121373
Left End Panel	Mill		115015
	Black Powder		121384
Gasket	Black Plastic		113782
Bezel	Black		113949

RS - 5020

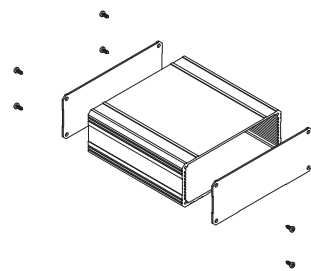
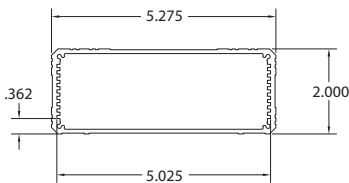

Description	Finish	Size	P/N
Enclosure Base	Mill	6" long	121387
	Mill	8" long	115076
	Black Powder	6" long	121388
	Black Powder	8" long	121389
Flat End Panel	Mill		114999
	Black Powder		117180
Left End Panel	Mill		115000
	Black Powder		121386
Gasket	Black		118353

RP - 6030

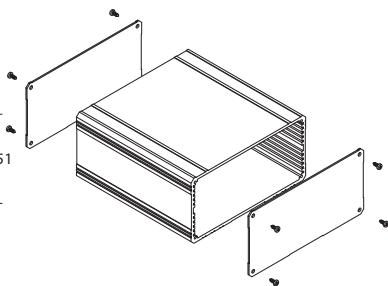
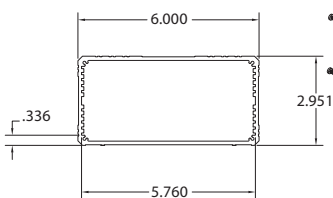

Description	Finish	Size	P/N
Enclosure Base	Mill	6" long	121385
	Mill	8" long	114897
	Black Powder	6" long	121400
	Black Powder	8" long	121401
Flat End Panel	Mill		115083
	Black Powder		121402
Left End Panel	Mill		114901
	Black Powder		121403
Gasket	Black		121012

Aluminum Enclosures

RS - 6520

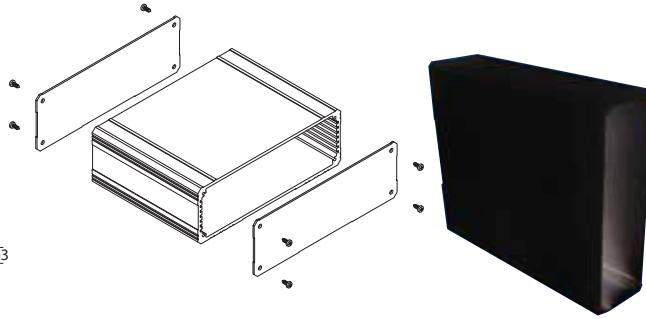
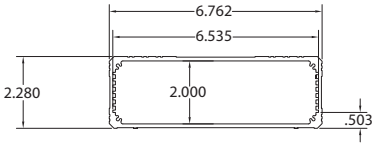

RS - 6520S

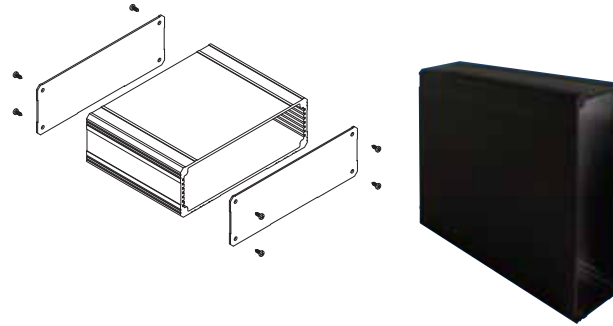
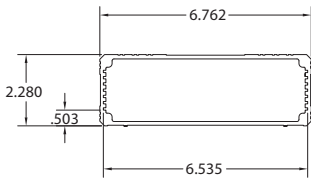

RP - 3025

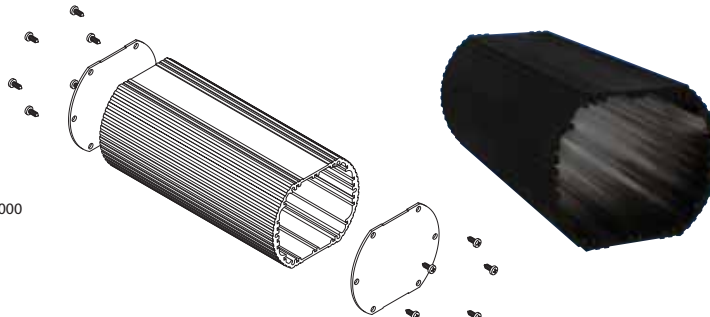
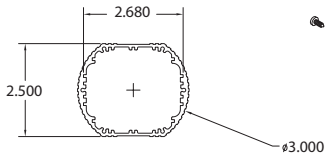

WS - 4517

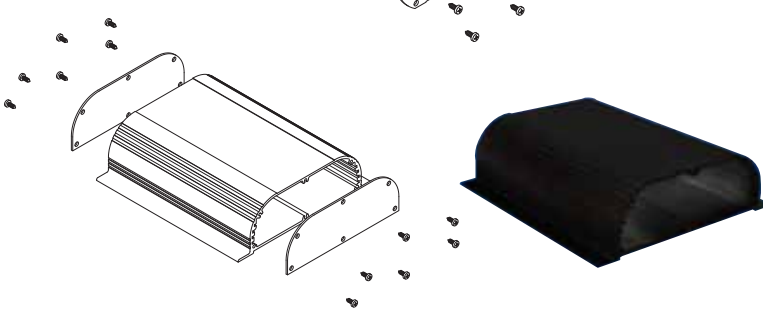
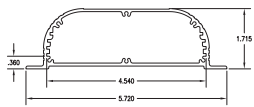

Description	Finish	Size	P/N
Enclosure Base	Mill	6" long	121422
	Mill	8" long	114902
	Black Powder	6" long	121427
	Black Powder	8" long	121430
Flat End Panel	Mill		114928
	Black Powder		121432
Left End Panel	Mill		115180
	Black Powder		121439
Gasket	Black		113936
End Bezel	Mill		115058
	Black Powder		121444
Plastic Bezel	Black Plastic		113780

Description	Finish	Size	P/N
Enclosure Base	Mill	6" long	121483
	Mill	8" long	114907
	Black Powder	6" long	121482
	Black Powder	8" long	121480
Flat End Panel	Mill		114928
	Black Powder		121432
Left End Panel	Mill		115180
	Black Powder		121439
Gasket	Black		113936
End Bezel	Mill		115058
	Black Powder		121444
Plastic Bezel	Black Plastic		113780

Description	Finish	Size	P/N
Enclosure Base	Mill	4" long	115018
	Mill	6" long	121203
	Black Powder	4" long	121204
	Black Powder	6" long	121205
Flat End Panel	Mill		115019
	Black Powder		121274
Gasket	Black Powder		114594

Description	Finish	Size	P/N
Enclosure Base	Mill	4" long	115174
	Mill	6" long	121368
	Black Powder	4" long	115080
	Black Powder	6" long	121369
Flat End Panel	Mill		114336
	Black Powder		117646
Gasket	Black Powder		119721

Additional Accessories



Description	Finish	P/N	Qty.
Self Tapping Screw	Black	113846	Pkg. of 10
	Zinc	113845	Pkg. of 10



sales@xtech-outside.com
 358 North Street, Randolph, MA 02368
 www.XTech-Outside.com
 US Sales: 1-888-444-1644